

Article number: 6160403525

Description: Welding hub for taper bush type MSB
for taper bush 3525

Measures

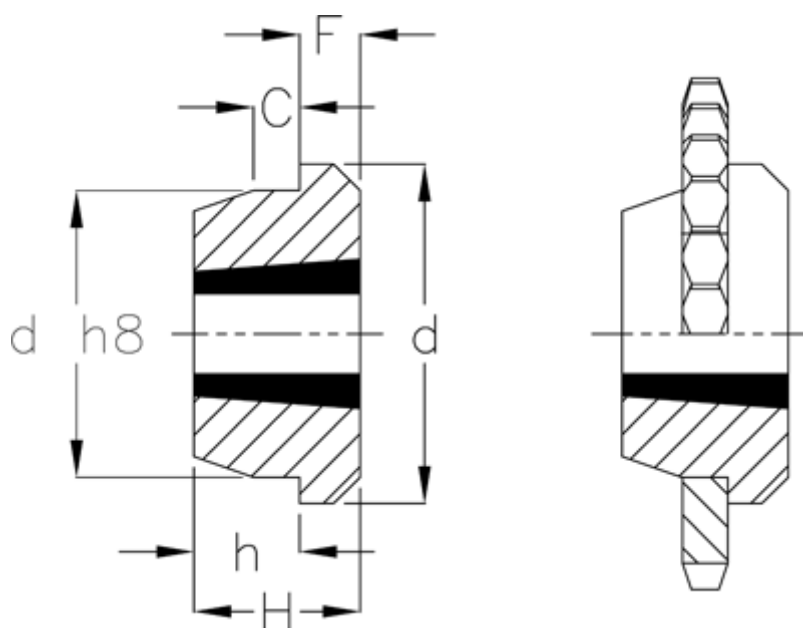

C	= 25
d	= 184
d H8	= 155
F	= 25
For taper bush = 3525	
H	= 65
h	= 40